

ZONE 21&2,22

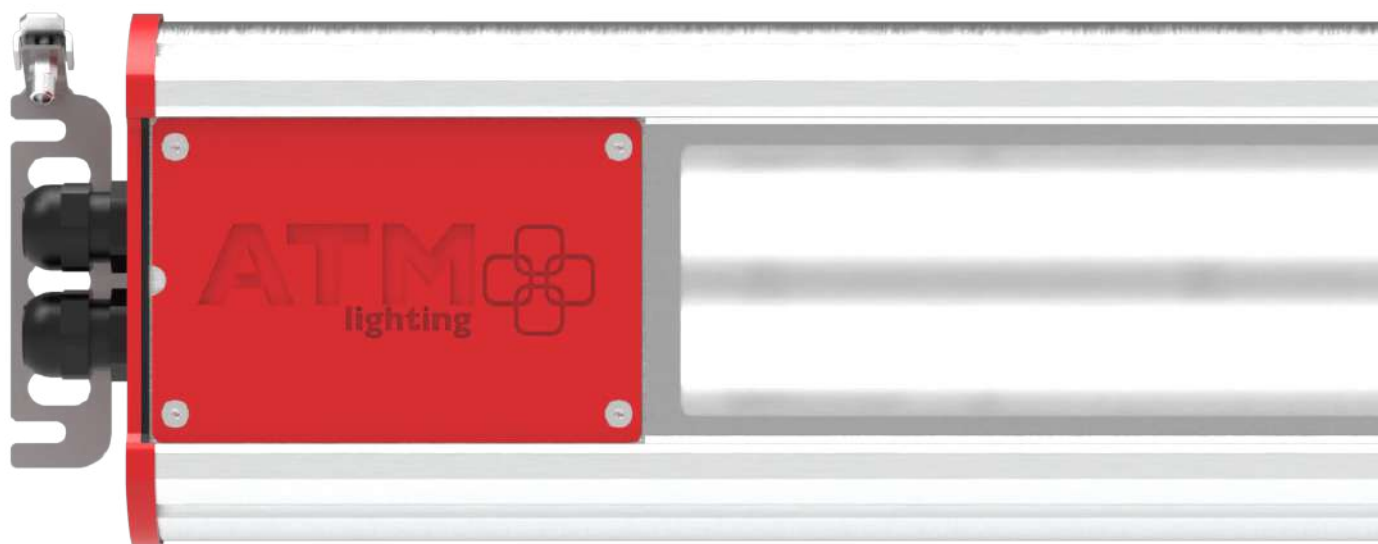

EXL400LED

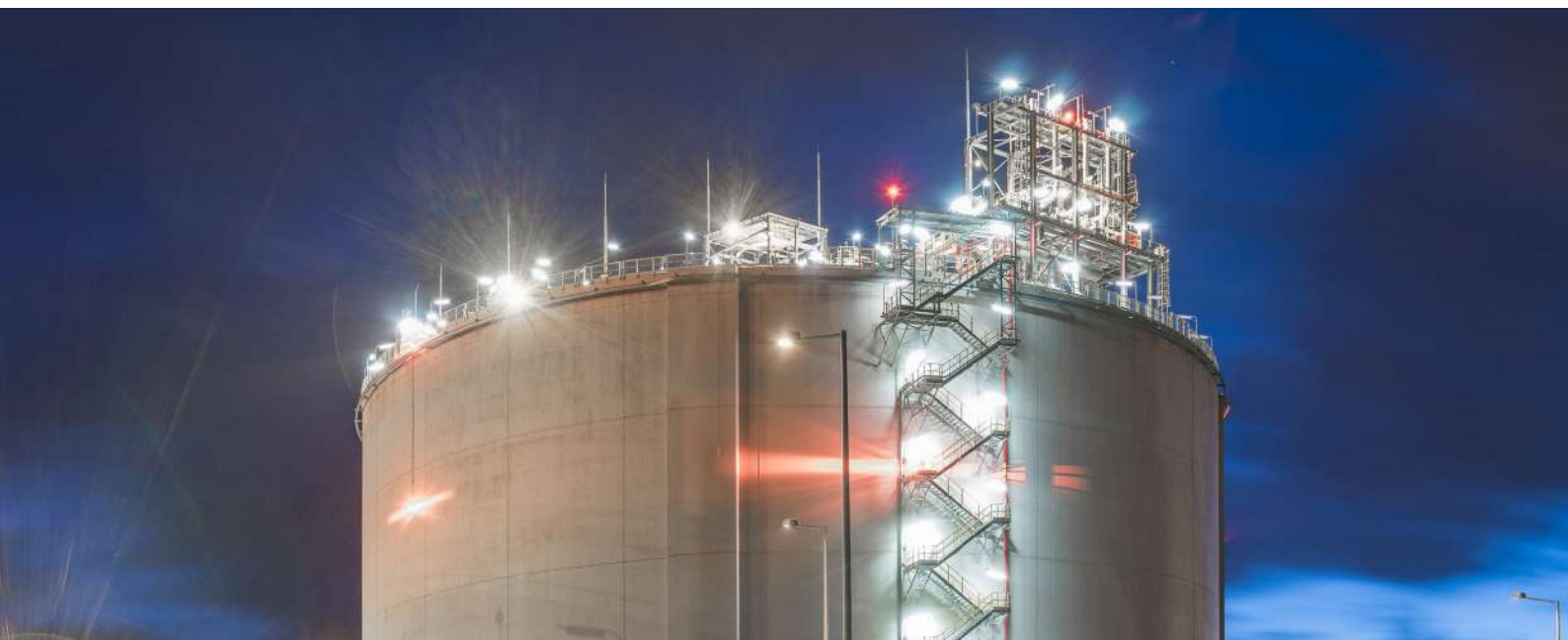



VERSION WITH A PICTOGRAM

option ZB - no LED indicator.



standard version Ex II 3G Ex ec IIC T6/T5 Gc
II 2D Ex tb IIIC T75°C/T100°C Db

EX MARKING:

Execution for high temperature operation

Ex II 3G Ex ec IIC T6/T5 Gc
II 3D Ex tc IIIC T75°C/T100°C Dc

CERTIFICATES:

OBAC 21 ATEX 0060X

CNBOP 5061/2023

EXEMPLARY APPLICATIONS

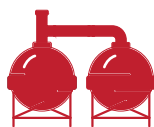

REFINERIES

FUEL
TANKSCHEMICAL
PLANTSCHEMICAL
WAREHOUSESPASSAGeways
IN EX ZONES





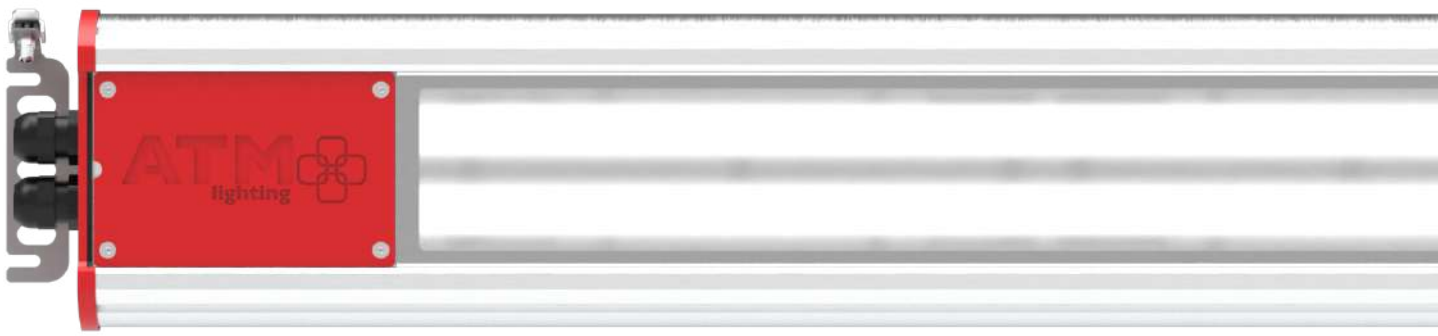

Explosionproof light fitting with **LED modules**. Designed to work in the zone **21 & 2.22** of the explosion hazard of gases, vapors and mists of flammable liquids with air, as well as of flammable dusts and fibers. The housing is made of aluminum and the diffuser is made of polycarbonate or tempered glass.

Optional version with autonomous **A3**, compatible with central battery **ZB**, or power source or DALI-2 control system **DA**.







FEATURES



MECHANICAL PARAMETERS

	housing	anodized aluminum (ALU)
	diffuser	tempered glass (GL) polycarbonate (PC) polimethyl methacrylate (PM)
	ingress protection	IP66 / IP67
	protection class	I
	shock resistance	GL: IK09 PC: IK10
	accessibility	revision cover

ELECTRICAL PARAMETERS

2,5 mm ²		connection terminals
35E: 220-240V 50-60Hz 220-240V 0Hz, 34E: 220-240V 50-60Hz, 11E: 24V 0Hz		input voltage
certified LED modules		light source
>0,97		power factor
Ø20 (wiring 6-13mm) Ø25 - option (wiring 9-17mm)		cable inlets
35E: 1kV (L-N), 2kV (L-PE) 4kV (L-N), 4kV (L-PE) - option* 34E: 1kV (L-N), 2kV (L-PE) * - not available for version 0300		overvoltage protection

PARAMETRY PRACY

	ambient temperature	-40°C to max. +60°C check: types comparison
	lifetime	>70.000h L ₈₀ B ₁₀ >100.000h L ₇₀ B ₁₀

PARAMETRY FOTOMETRYCZNE

>80 >90 - optionally		CRI
4000K 6500K - optionally		color temperature



As standard, the housing is equipped with a 20 gland system (two glands on one side of the housing). This housing can be used both as an end and a through (double-sided or single-sided). The glands are equipped with sealing plugs and should be left in place if the glands are not used.

DIMENSIONS

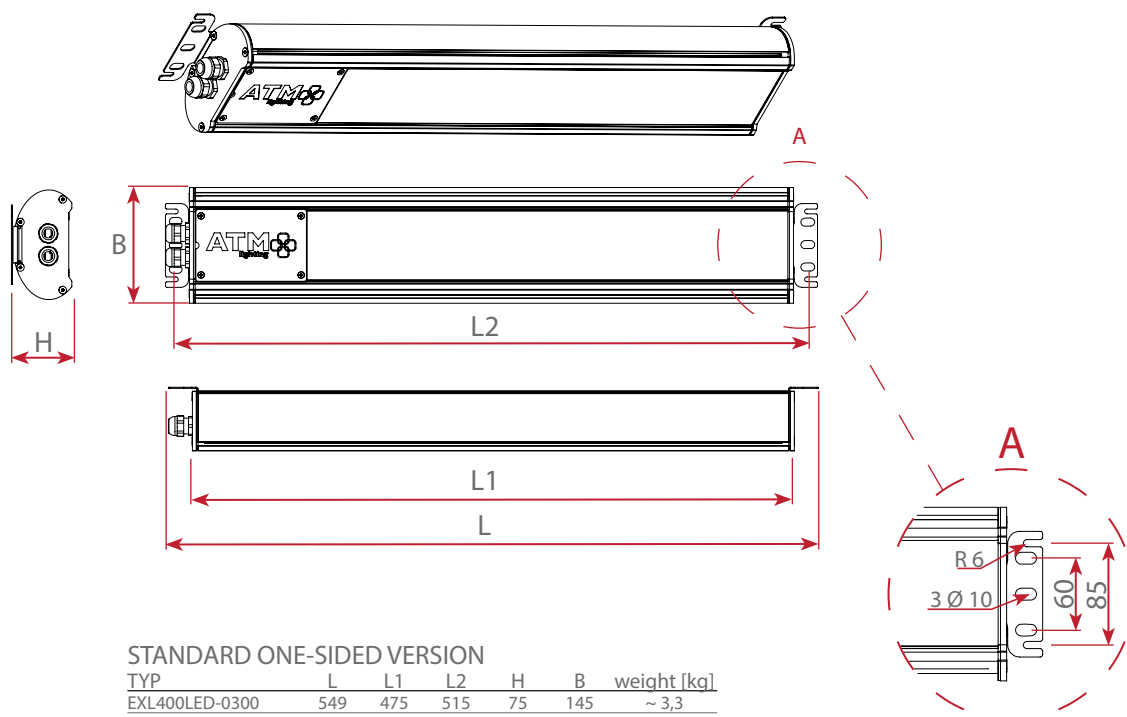

STANDARD ONE-SIDED VERSION

TYP	L	L1	L2	H	B	weight [kg]
EXL400LED-0300	549	475	515	75	145	~ 3,3
EXL400LED-0600	829	755	795	75	145	~ 4,7
EXL400LED-1200	1389	1315	1355	75	145	~ 7,5
EXL400LED-1500	1669	1595	1635	75	145	~ 9,2

EMERGENCY ONE-SIDED VERSION

TYP	L	L1	L2	H	B	weight [kg]
EXL400LED-0300-...-A3S	599	525	565	75	145	~ 3,8
EXL400LED-0600-...-A3S	879	805	845	75	145	~ 5,2
EXL400LED-1200-...-A3S	1439	1365	1405	75	145	~ 8,0
EXL400LED-1500-...-A3S	1719	1645	1685	75	145	~ 9,7

MAXIMUM NUMBER OF LINEARLY CONNECTED LUMINAIRES

MAXIMUM NUMBER OF LINE CONNECTED LUMINAIRES DEPENDING ON THE CIRCUIT BREAKERS USED

⚡ 35E (1/2kV)

Type	B16	C16	Max. starting current	Starting time
EXL400LED-1200-E8-3	6	11	54A	< 125 µs
EXL400LED-1500-E10-1				
Other	12	21	54A	< 125 µs

⚡ 35E (4/4kV)

Type	B16	C16	Max. starting current	Starting time
EXL400LED-0300	-	-	-	-
EXL400LED-1500-E10-1	16	27	5A	< 1000 µs
Other	32	53	5A	< 1000 µs

⚡ 34E (1/2kV)

Typ	B16	C16	Max. starting current	Starting time
EXL400LED-1200-E8-3	6	11	64A	< 125 µs
EXL400LED-1500-E10-1				
Other	12	21	64A	< 125 µs

TYPES COMPARISON

luminaires for ambient temperature +45°C (Ta=45°C) **II 3G Ex ec IIC T6 Gc**
II 2D Ex tb IIIC T75°C Db

luminaires for ambient temperature +60°C (Ta=60°C) **II 3G Ex ec IIC T5 Gc**
II 3D Ex tc IIIC T100°C Dc

NARROW BEAM OPTICS - NB

TYPE	LUMINOUS FLUX [lm]	POWER CONSUMP. [W]	EFFICIENCY [lm/W]	MAX. TEMP. / TEMP. CLASS
EXL400LED-0300-E1-2	1462	11	133	+45°C/T6 or +60°C/T5
EXL400LED-0300-E2-1	2500	16,9	148	+45°C/T6 or +60°C/T5
EXL400LED-0600-E2-2	2942	22,1	133	+45°C/T6 or +60°C/T5
EXL400LED-0600-E2-3	3379	25,3	134	+45°C/T6 or +60°C/T5
EXL400LED-0600-E4-1	5055	32	158	+45°C/T6 or +60°C/T5
EXL400LED-0600-E4-2	5904	40,9	144	+45°C/T6 or +60°C/T5
EXL400LED-1200-E4-2	5609	40,9	137	+45°C/T6 or +60°C/T5
EXL400LED-1200-E4-3	6803	47,3	144	+45°C/T6 or +60°C/T5
EXL400LED-1200-E8-1	10034	62,4	161	+45°C/T6 or +60°C/T5
EXL400LED-1200-E8-2	11732	79,7	147	+45°C/T6 or +60°C/T5
EXL400LED-1200-E8-3	13487	91,3	148	+45°C/T6 or +60°C/T5
EXL400LED-1500-E5-2	7592	50,7	150	+45°C/T6 or +60°C/T5
EXL400LED-1500-E5-3	8695	59	147	+45°C/T6 or +60°C/T5
EXL400LED-1500-E10-1	11601	78,6	148	+45°C/T6 or +60°C/T5

WIDE BEAM OPTICS - WB

TYPE	LUMINOUS FLUX [lm]	POWER CONSUMP. [W]	EFFICIENCY [lm/W]	MAX. TEMP. / TEMP. CLASS
EXL400LED-0300-E1-2	1413	11	128	+45°C/T6 or +60°C/T5
EXL400LED-0300-E2-1	2416	16,9	143	+45°C/T6 or +60°C/T5
EXL400LED-0600-E2-2	2844	22,1	129	+45°C/T6 or +60°C/T5
EXL400LED-0600-E2-3	3266	25,3	129	+45°C/T6 or +60°C/T5
EXL400LED-0600-E4-1	4973	32	155	+45°C/T6 or +60°C/T5
EXL400LED-0600-E4-2	5808	40,9	142	+45°C/T6 or +60°C/T5
EXL400LED-1200-E4-2	5518	40,9	135	+45°C/T6 or +60°C/T5
EXL400LED-1200-E4-3	6692	47,3	141	+45°C/T6 or +60°C/T5
EXL400LED-1200-E8-1	9872	62,4	158	+45°C/T6 or +60°C/T5
EXL400LED-1200-E8-2	11542	79,7	145	+45°C/T6 or +60°C/T5
EXL400LED-1200-E8-3	13269	91,3	145	+45°C/T6 or +60°C/T5
EXL400LED-1500-E5-2	7352	50,7	145	+45°C/T6 or +60°C/T5
EXL400LED-1500-E5-3	8420	59	143	+45°C/T6 or +60°C/T5
EXL400LED-1500-E10-1	11234	78,6	143	+45°C/T6 or +60°C/T5

luminaires for ambient temperature +45°C (Ta=45°C) **II 3G Ex ec IIC T6 Gc**
II 2D Ex tb IIIC T75°C Db

luminaires for ambient temperature +50°C (Ta=60°C) **II 3G Ex ec IIC T5 Gc**
II 2D Ex tb IIIC T100°C Dc

NARROW BEAM OPTICS NB - power supply 24VDC

TYPE	LUMINOUS FLUX [lm]	POWER CONSUMP. [W]	EFFICIENCY [lm/W]	MAX. TEMP. / TEMP. CLASS
EXL400LED-0300-I1	1646	13,2	125	+45°C/T6 lub +50°C/T5
EXL400LED-0300-I2	3293	28,4	116	+45°C/T6 lub +50°C/T5
EXL400LED-0600-I2	3315	28,4	117	+45°C/T6 lub +50°C/T5
EXL400LED-0600-I4	6513	52,8	123	+45°C/T6 lub +50°C/T5
EXL400LED-1200-I4	6191	52,8	117	+45°C/T6 lub +50°C/T5
EXL400LED-1200-I8	12380	105,6	117	+45°C/T6 lub +50°C/T5
EXL400LED-1500-I5	7862	66,0	119	+45°C/T6 lub +50°C/T5
EXL400LED-1500-I10	15722	132,0	119	+45°C/T6 lub +50°C/T5

WIDE BEAM OPTICS WB - power supply 24VDC

TYPE	LUMINOUS FLUX [lm]	POWER CONSUMP. [W]	EFFICIENCY [lm/W]	MAX. TEMP. / TEMP. CLASS
EXL400LED-0300-I1	1591	13,2	121	+45°C/T6 or +50°C/T5
EXL400LED-0300-I2	3182	28,4	112	+45°C/T6 or +50°C/T5
EXL400LED-0600-I2	3204	28,4	113	+45°C/T6 or +50°C/T5
EXL400LED-0600-I4	6408	52,8	121	+45°C/T6 or +50°C/T5
EXL400LED-1200-I4	6090	52,8	115	+45°C/T6 or +50°C/T5
EXL400LED-1200-I8	12180	105,6	115	+45°C/T6 or +50°C/T5
EXL400LED-1500-I5	7613	66,0	115	+45°C/T6 or +50°C/T5
EXL400LED-1500-I10	15225	132,0	115	+45°C/T6 or +50°C/T5



Luminous flux tolerance +/- 10%

Power tolerance +/- 10%

The parameters given in the following data sheet has been determined for the temperature Ta=25°C.

Luminous flux, light intensity distribution and efficiency has been tested on the basis of the standards EN ISO 17025:2005, norm series EN13032 and LM-79.

The actual data and General Warranty Conditions are available on our website www.atmlighting.pl

EMERGENCY VERSIONS

3h Emergency power module: **34E** Version with 3h emergency power module

II 3G Ex ec IIC T6 Gc
II 2D Ex tb IIIC T75°C Db

The luminaire can operate in temperature range from -20°C to +45°C.
The battery charging is not available below 0°C.

A3 luminaire type	mean emergency luminous flux [lm]	max. amb. temp. [°C]
EXL400LED-0300...-A3	584-799	45
EXL400LED-0600...-A3	719-806	45
EXL400LED-1200...-A3	730-803	45
EXL400LED-1500...-A3	716-808	45

ZB Central battery: **35E** Version adapted to be powered from central battery

In the emergency version powered by a central battery (ZB), the standard luminous flux is 50% of the reference value (*check types comparison*), but can be increased upon the Customer's request.

ZB luminaire type	mean emergency luminous flux [lm]	max. amb. temp. [°C]
EXL400LED-0300...-ZB	50%	45 / 60
EXL400LED-0600...-ZB	50%	45 / 60
EXL400LED-1200...-ZB	50%	45 / 60
EXL400LED-1500...-ZB	50%	45 / 60

OPTIONAL VERSIONS

DALI-2 driver: Version equipped with DALI-2 drive **DA**

Optionally, the housing can be equipped with an integrated power supply with a DALI-2 interface, which allows monitoring the operation of the fixture and controlling the lighting using data directly from motion sensors or from the building management system (BMS). A properly configured lighting control system can significantly reduce electricity costs and improve user ergonomics.
The DALI-2 power supply is available only for the 35E power version (220-240V, 50-60Hz).

VERSION WITH A PICTOGRAM

Pictogram dimensions: 320x85mm [LxB]

Brightness >200 cd/m2

The version with pictogram can only be selected for the 0300-E2-1 luminaire type.

Self adhesive pictograms kit:



Special order pictograms available for large orders.

In the case of the version with an emergency power supply module (A3S), a signal LED is visible next to the pictogram.



option ZB - no LED indicator.

TWO-SIDED VERSION

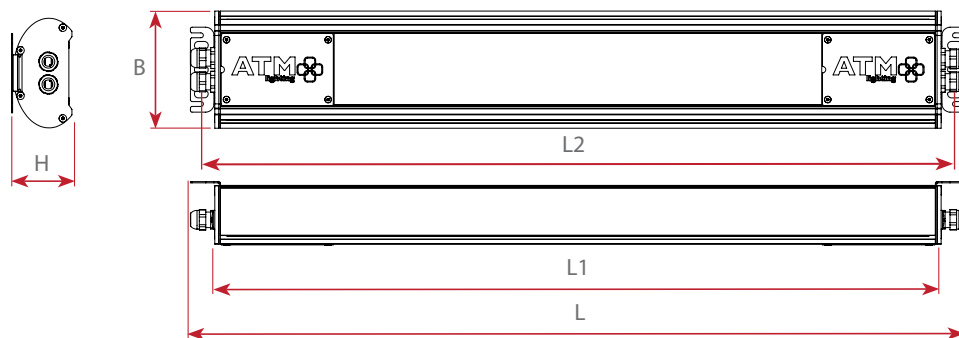

CROSS-WIRING TWO-SIDED VERSION

TYPE	L	L1	L2	H	B	weight [kg]
EXL400LED-0300	719	615	685	75	145	~ 5,0
EXL400LED-0600	999	895	965	75	145	~ 7,0
EXL400LED-1200	1559	1455	1525	75	145	~ 9,5
EXL400LED-1500	1839	1735	1805	75	145	~ 11,0

EMERGENCY CROSS-WIRING TWO-SIDED VERSION

TYPE	L	L1	L2	H	B	weight [kg]
EXL400LED-0300...-A3S	789	685	755	75	145	~ 6,0
EXL400LED-0600...-A3S	1069	965	1035	75	145	~ 7,0
EXL400LED-1200...-A3S	1629	1525	1595	75	145	~ 10,0
EXL400LED-1500...-A3S	1909	1805	1875	75	145	~ 12,0

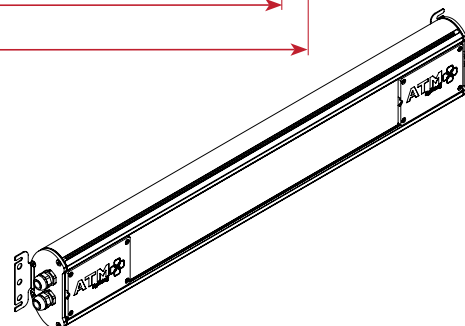

MOUNTINGS

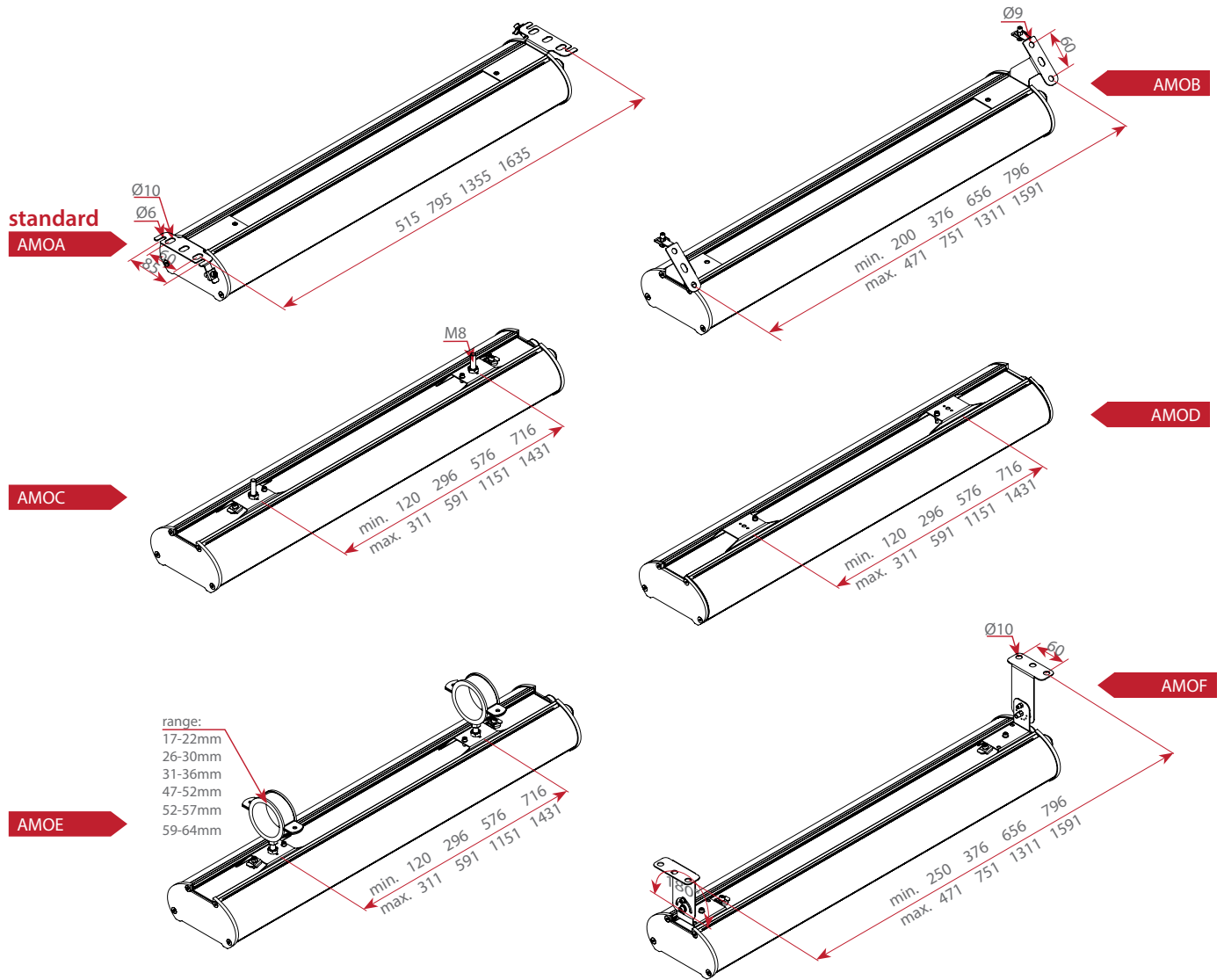

All dimensions are given for one-sided non-emergency light fittings for sizes: 0300, 0600, 1200, 1500. For mounting dimensions for other variants, please check the manual.

PHOTOMETRY

